

Mobiele Onderwijscontent

prof. dr. m. marcus specht

Centre for Learning Sciences and Technologies

CELSTEC.org

Centre for Learning Sciences and Technologies



Open Universiteit
celstec.org



OUNL and CELSTEC.org

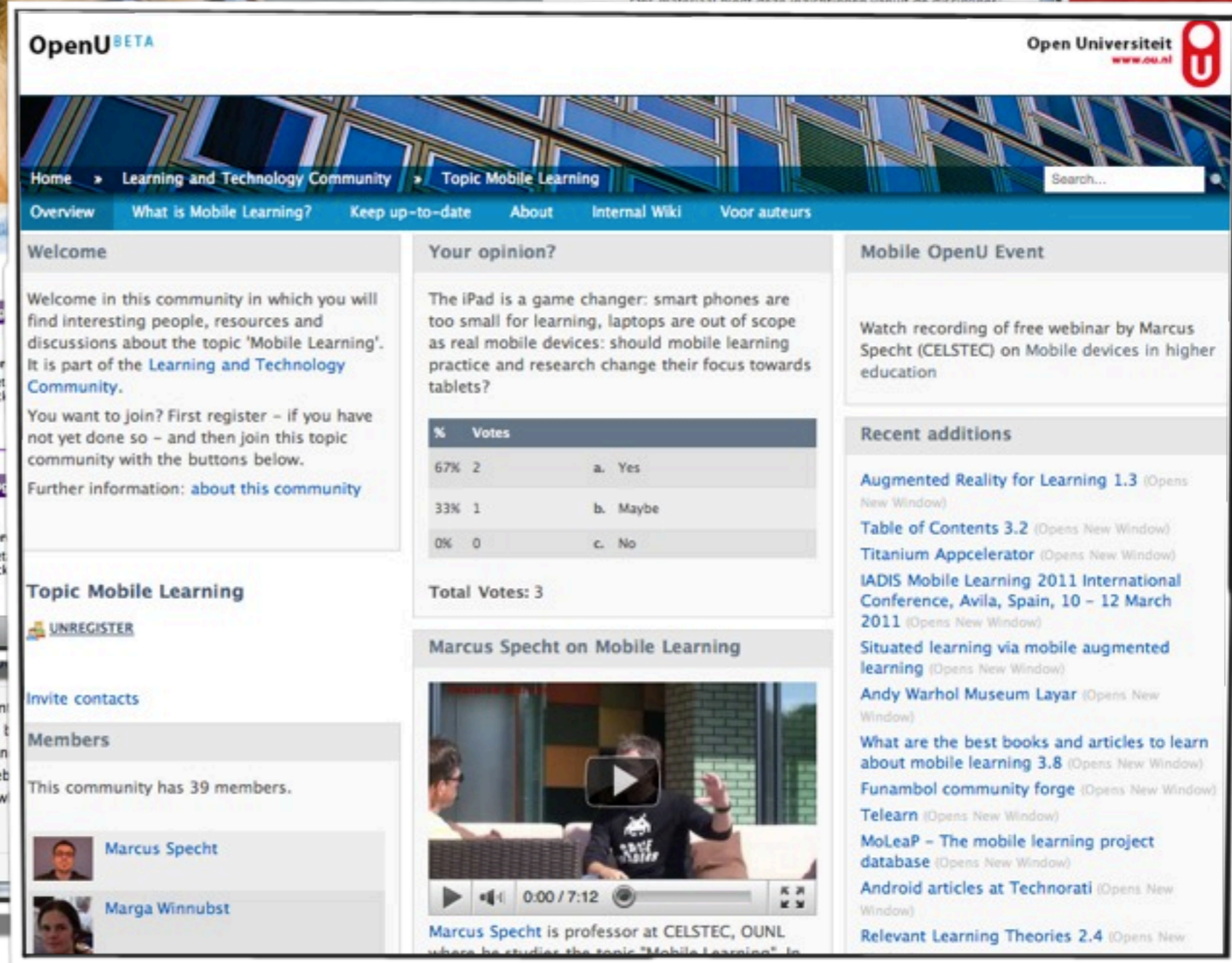
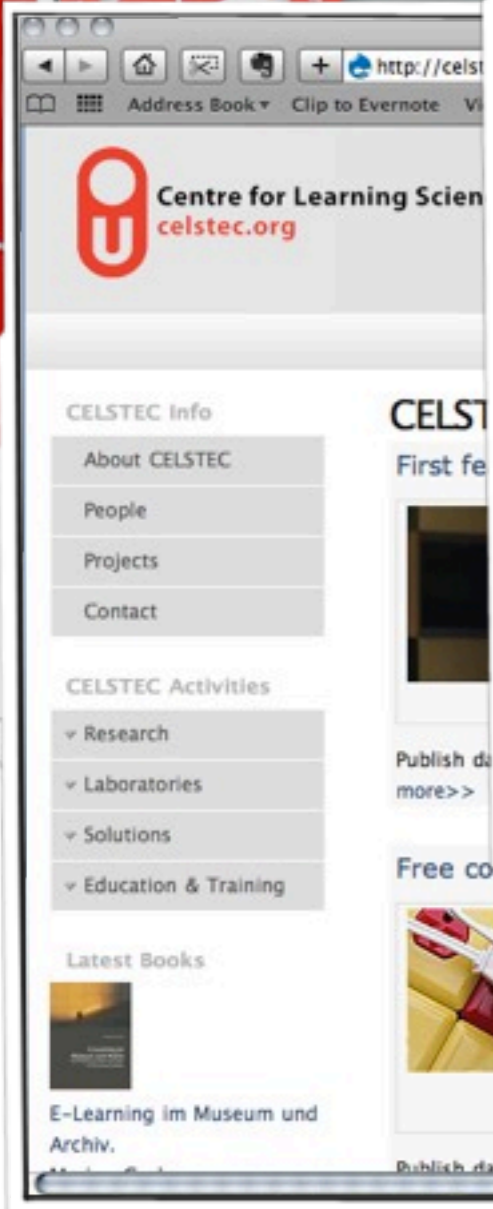
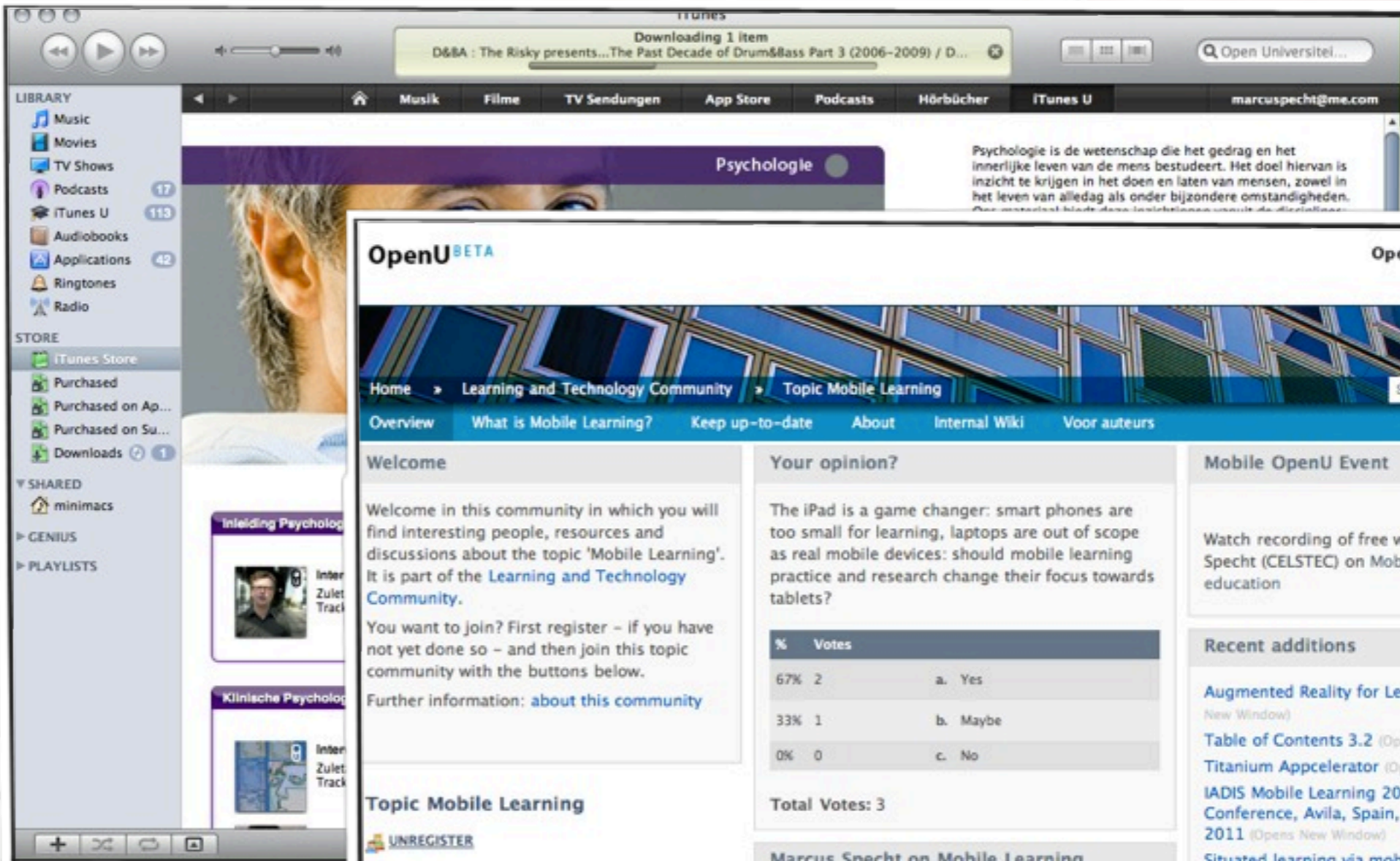
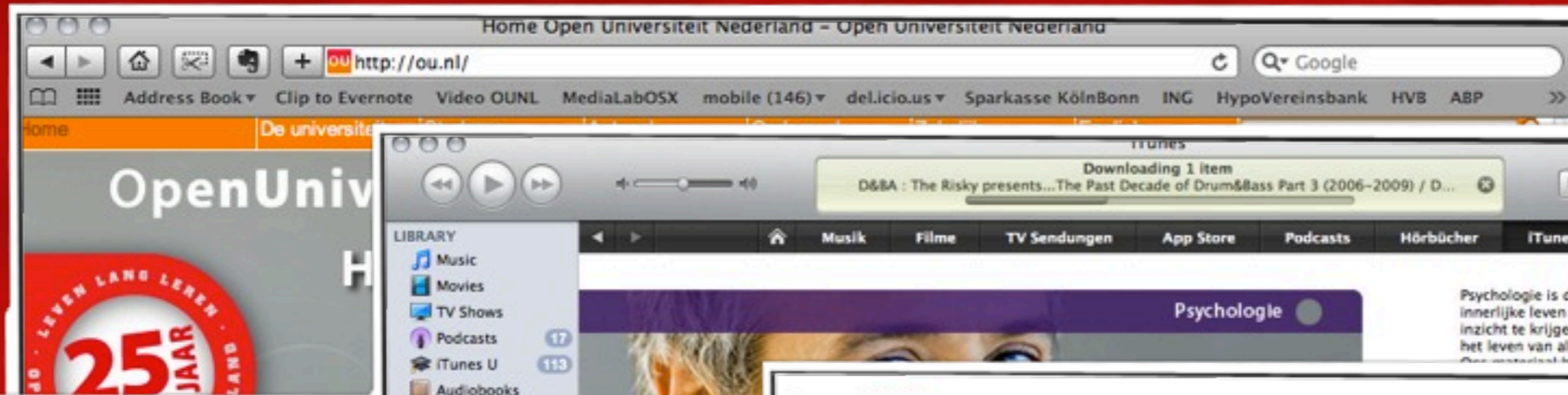

New media for learning and professional development

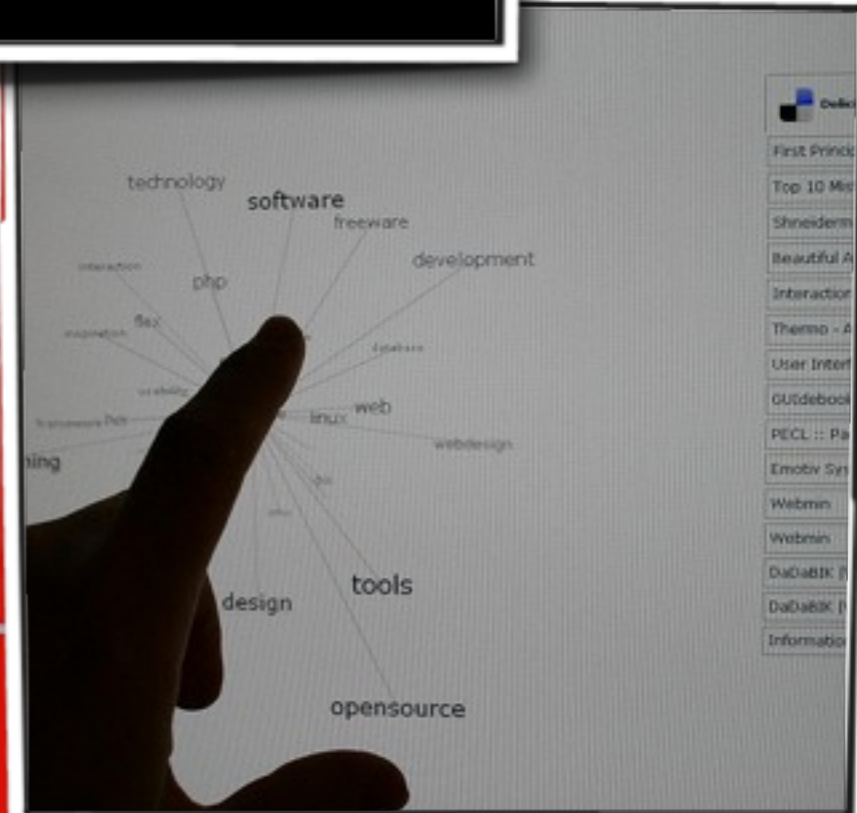
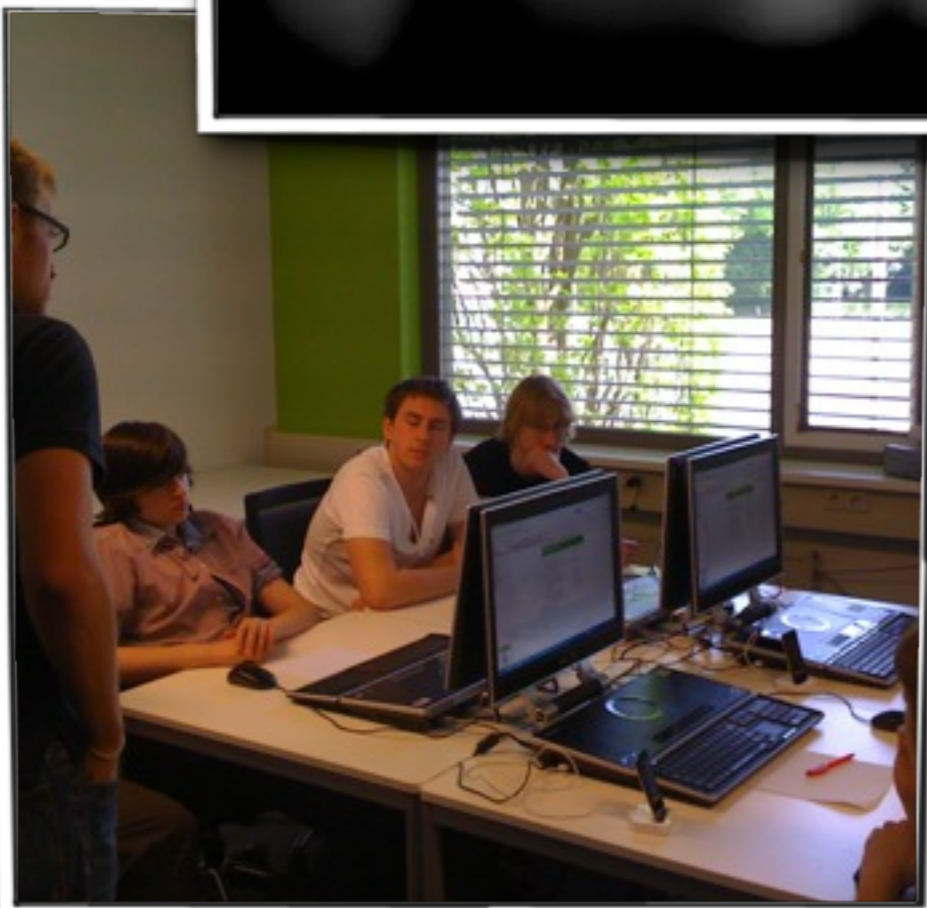

Mobiele Onderwijscontent

- #1 Podcasts and Vodcasts
 - OU Videobase, Metadata
 - iTunes U en Youtube EDU
- #2 eBooks en nieuwe content
 - Pilot RW, MW, NW, PSY
- #3 Mobiele LMS oplossingen
 - Mobile Moodle
 - Blackboard Mobile Learn
- #4 De Toekomst, Excursies, Augmented Reality



#1 Mobile Content Workflows for iTunesU and Youtube EDU

Centre for Learning Sciences and Technologies

Open Universiteit
celstec.org



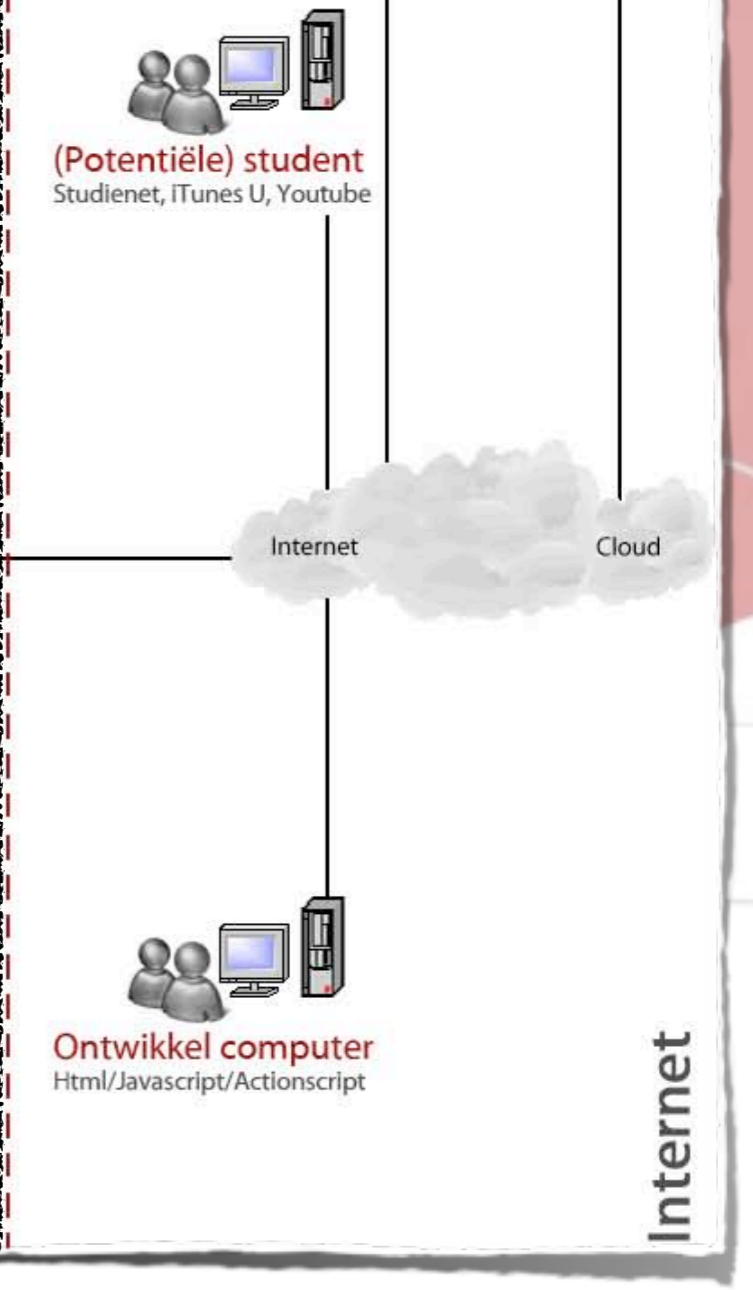
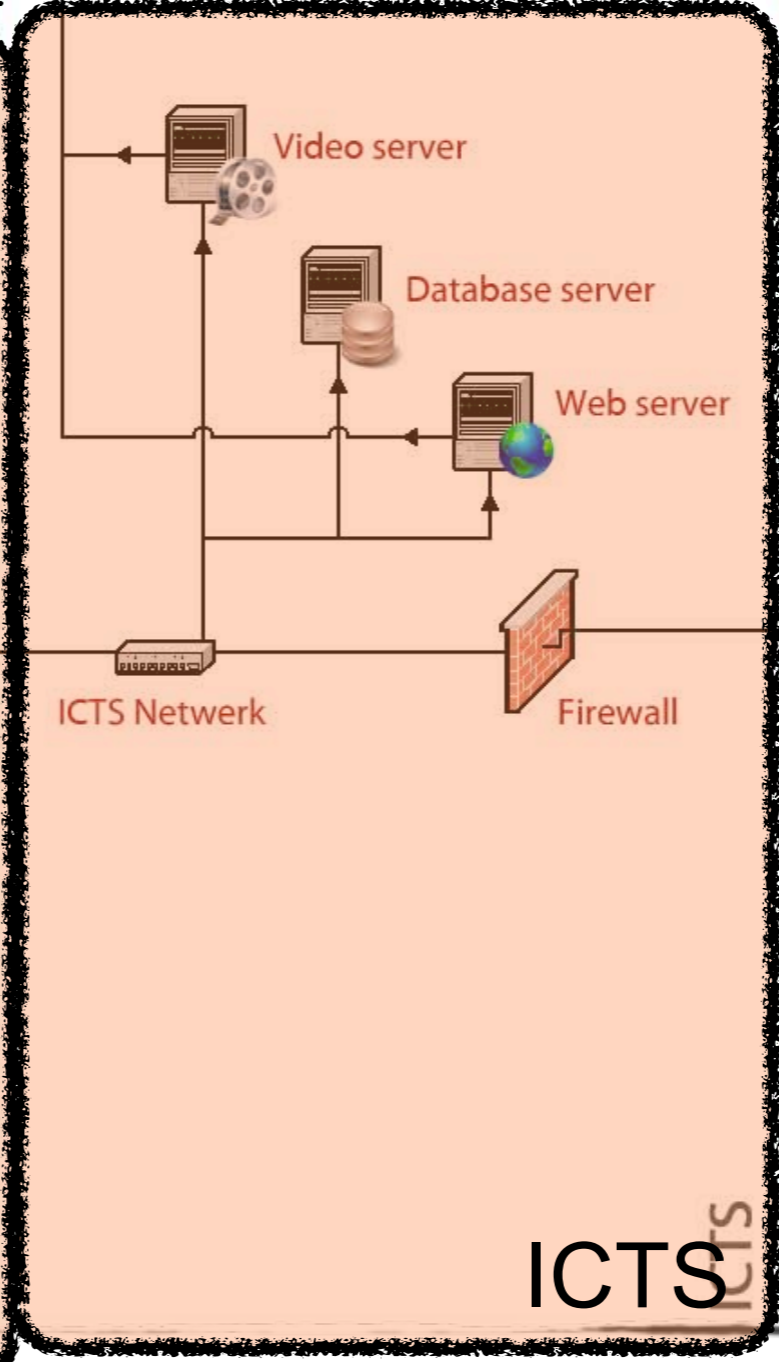
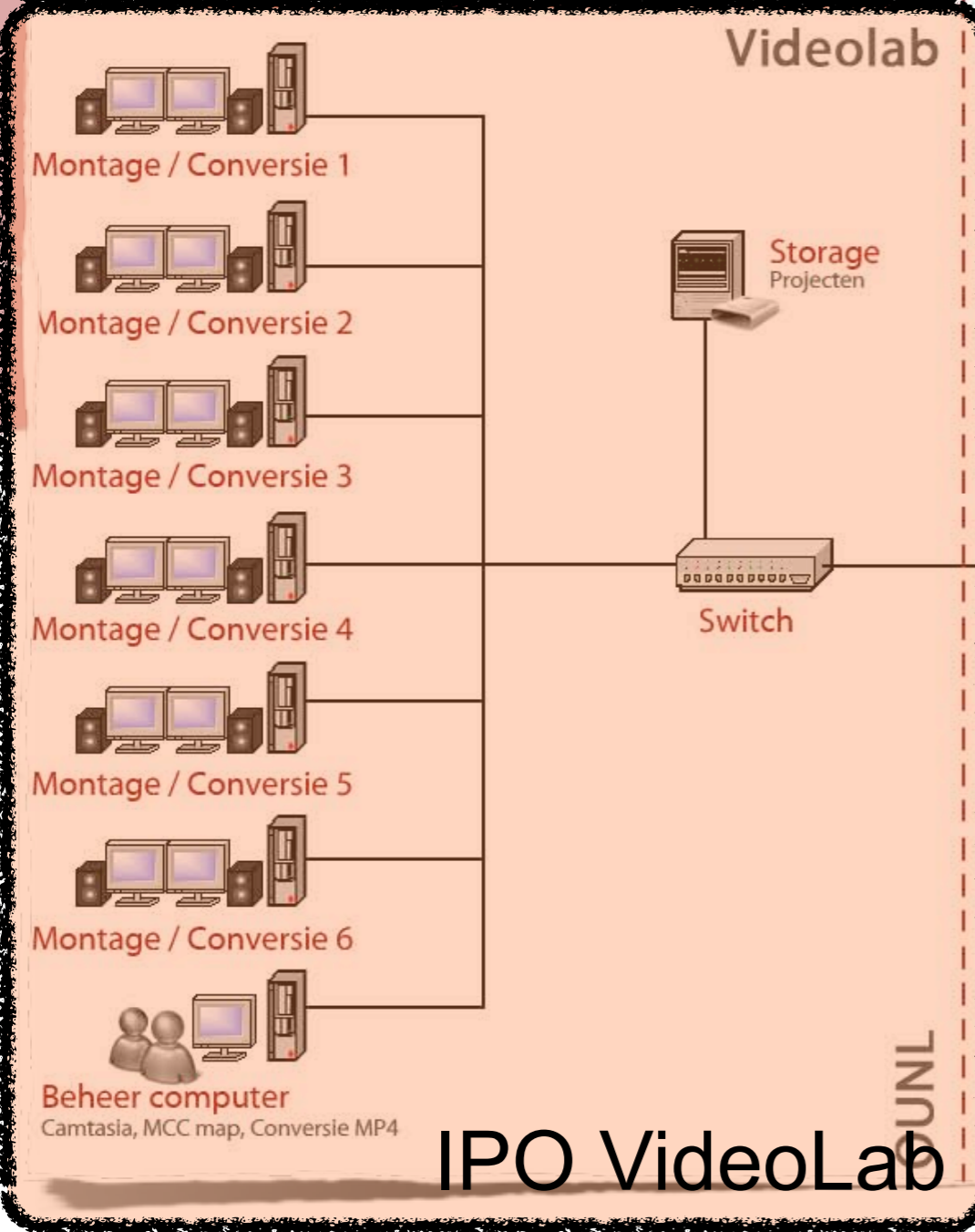
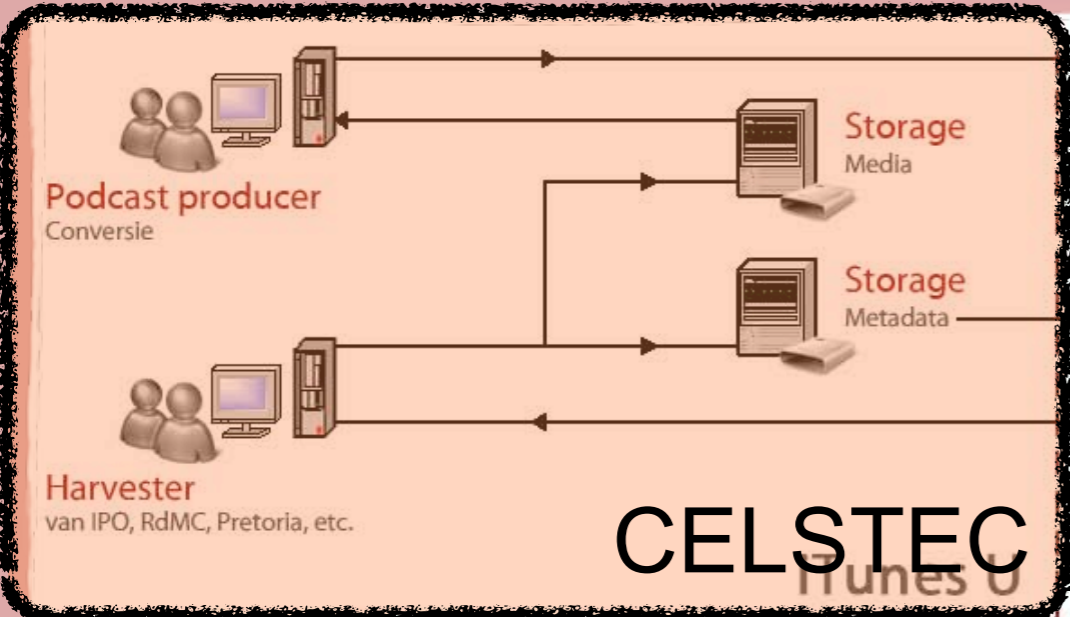

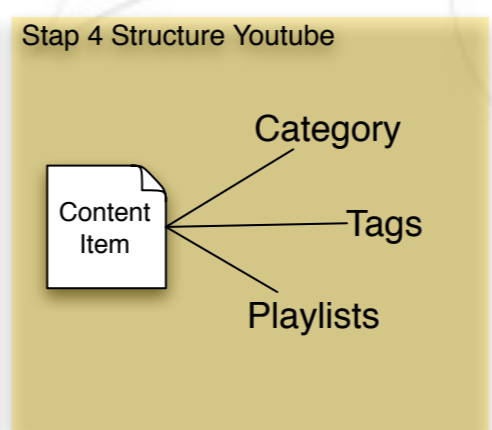
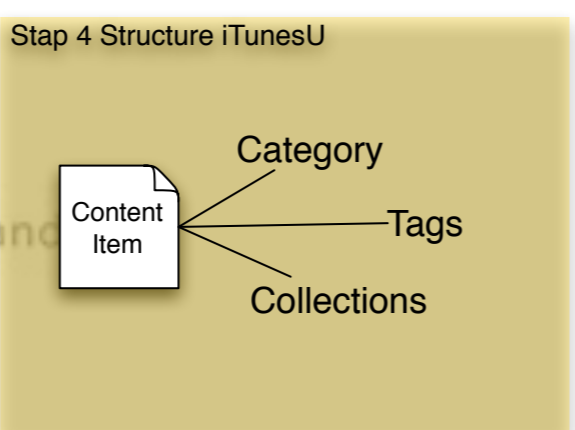
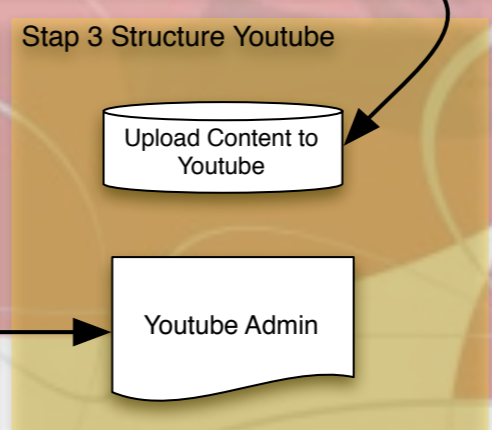
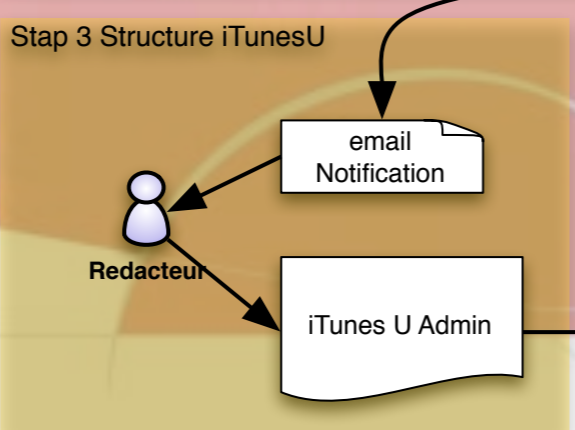
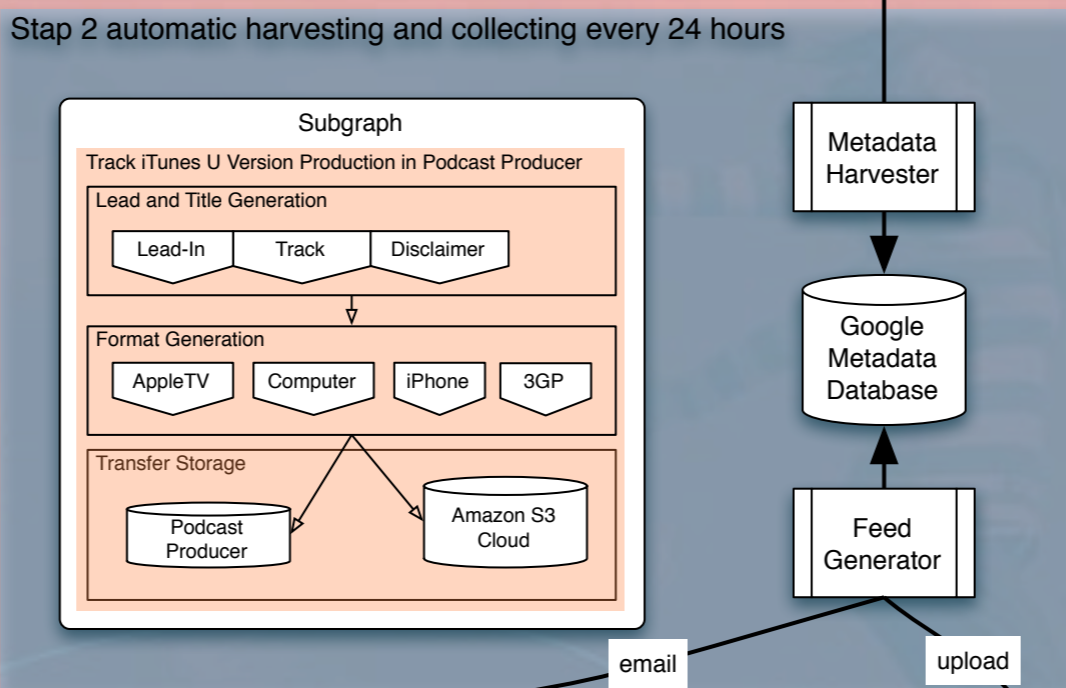
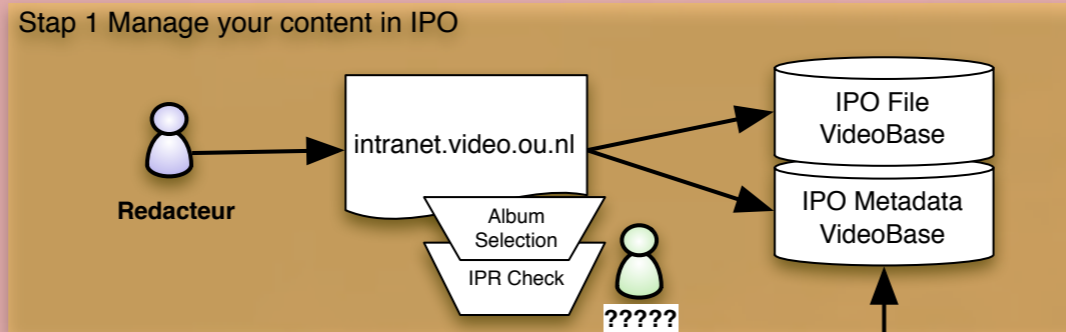

Step 1

Stap 1 Manage your content in IPO

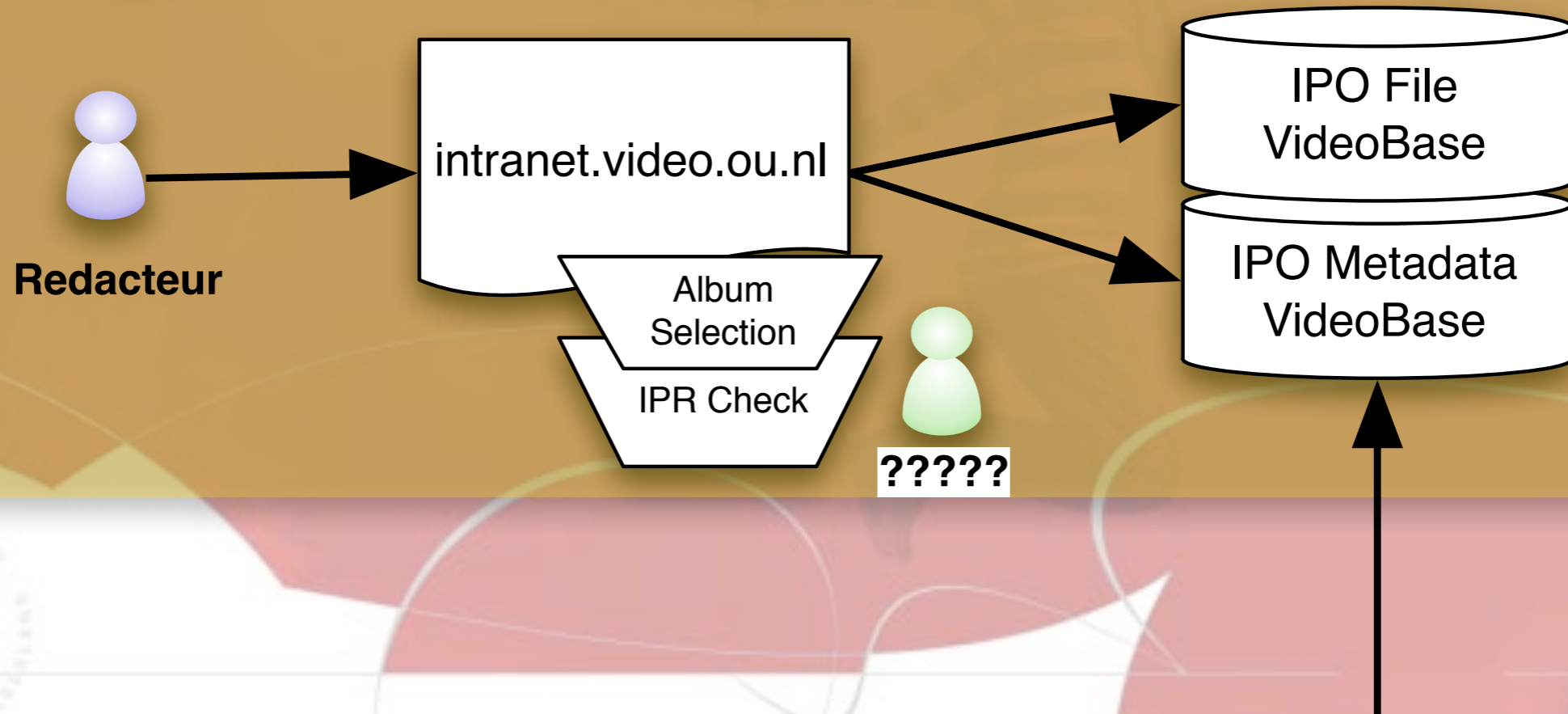

25 JAAR
GENERATIE 1880-2005



Step 2

Step 2 automatic harvesting and collecting every 24 hours

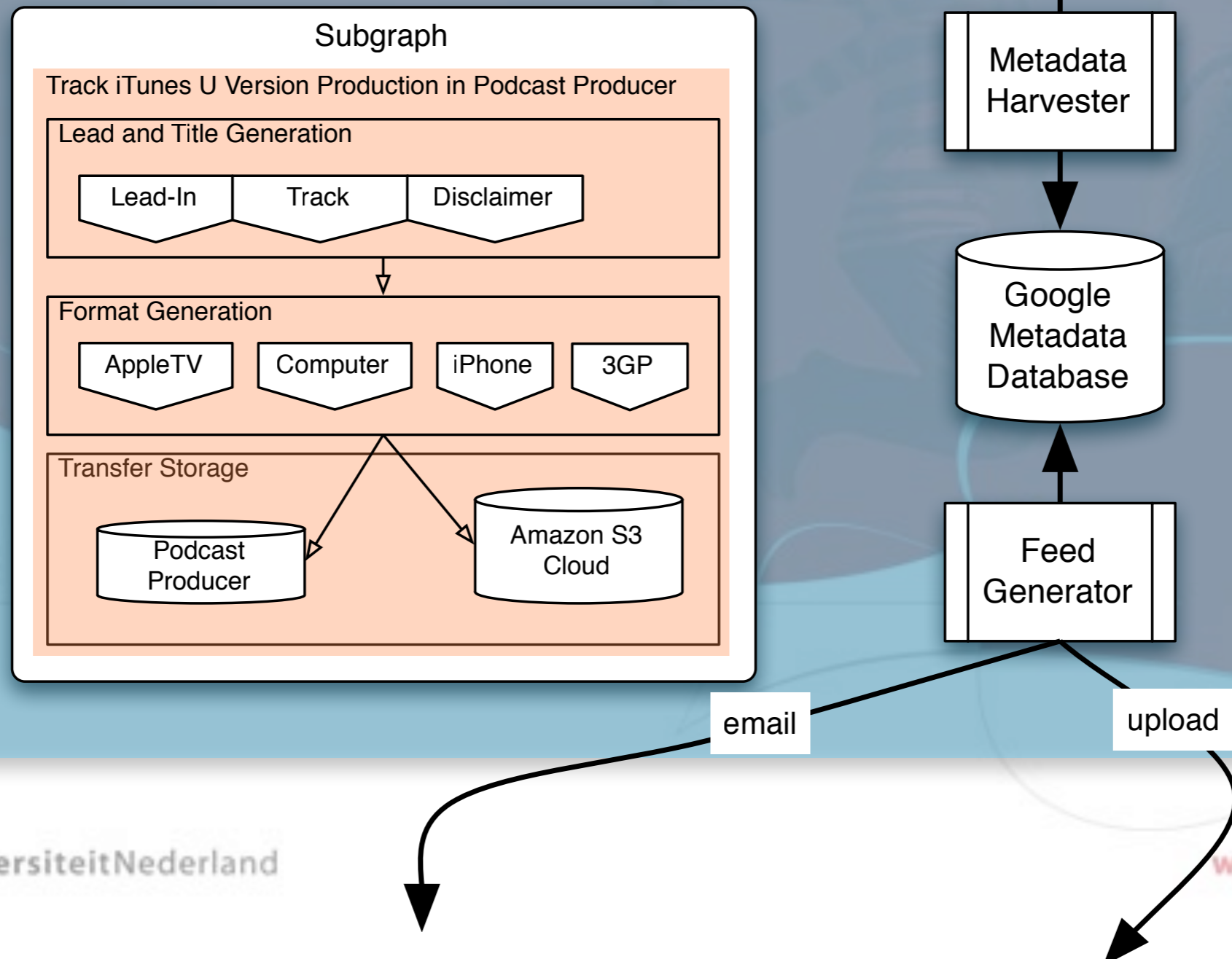

Step 3 and 4

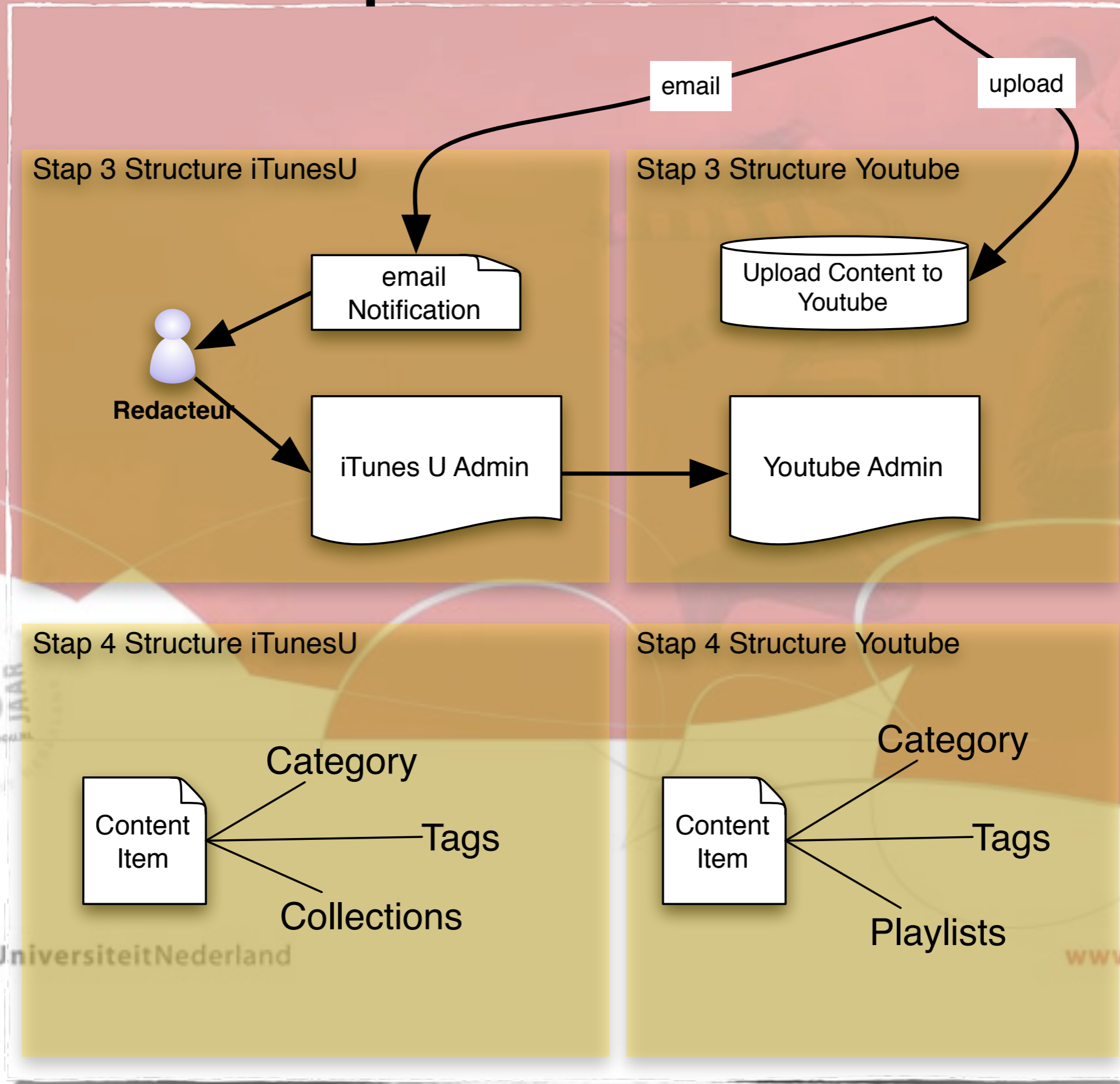

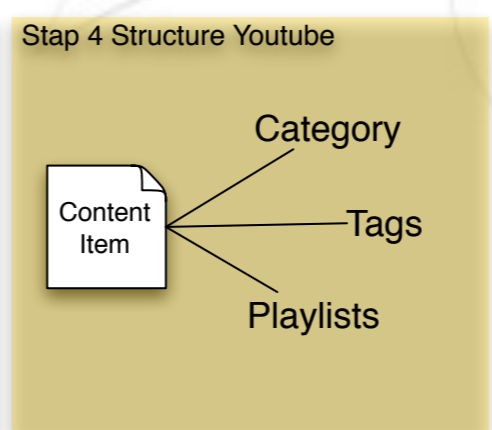
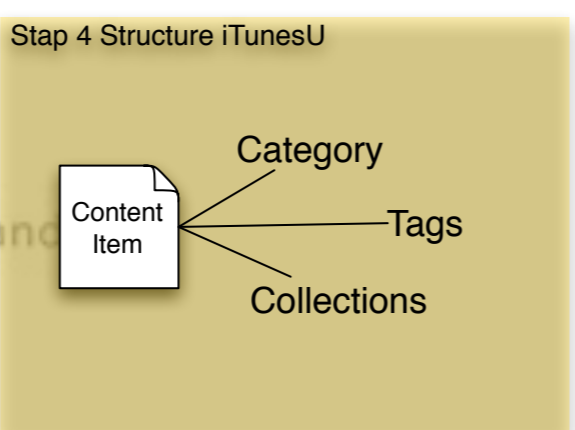
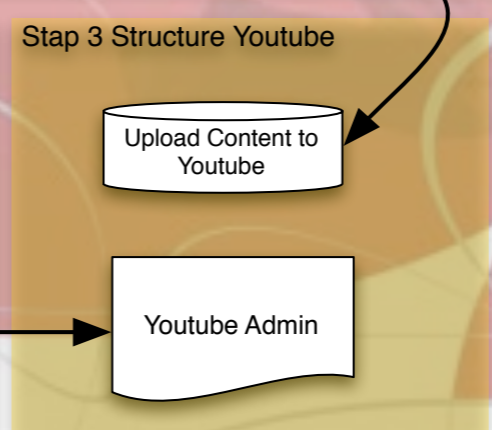
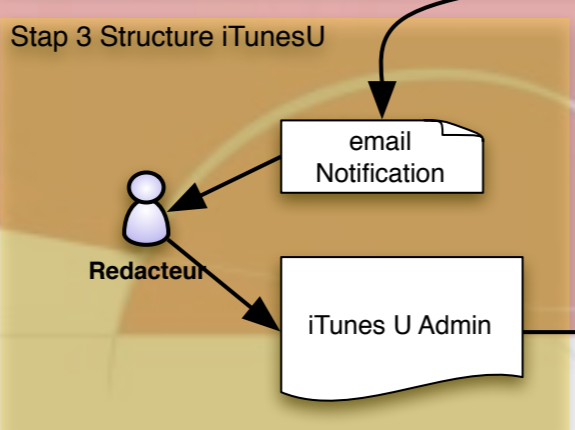
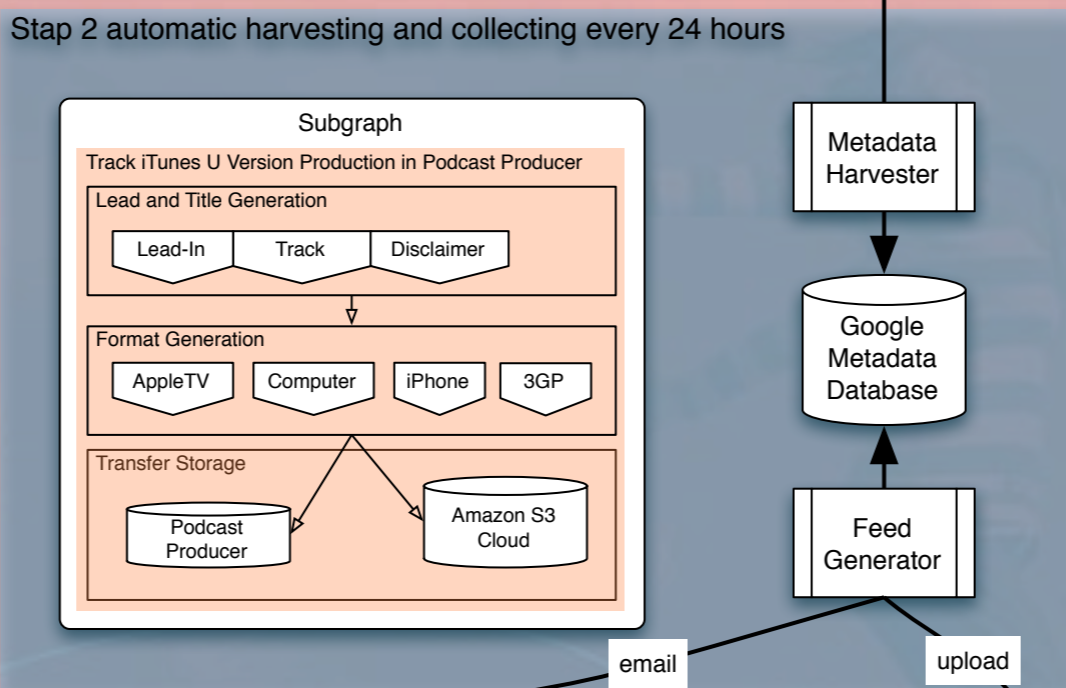
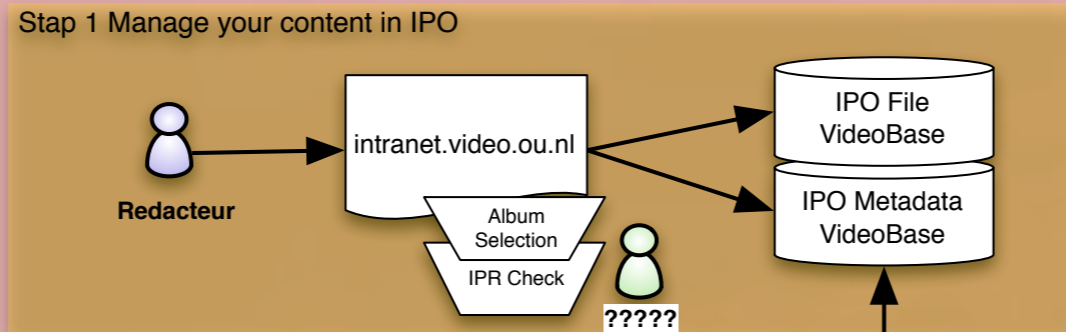

creation and management of iTunes U channel and media workflows for the OU



De Open Universiteit ontwikkelt, verzorgt en bevordert, samenwerkend in netwerken en allianties, hoogwaardig en innovatief hoger afstandsonderwijs. Als dé universiteit voor leven-lang-leren stelt zij de uiteenlopende leerbehoeften van mensen in hun levensloop én de noodzaak tot aanzienlijke verhoging van het kennisniveau van de samenleving centraal.

LINKS

www.ou.nl
Studietest

Open Universiteit Nederland



Het onderwijs van de Open Universiteit ...
Zuletzt geändert: 15. Apr 2010
Tracks insgesamt: 18

Nieuw



Business rules als cool concept
Zuletzt geändert: 14. Apr 2010
Tracks insgesamt: 3

Interessegebieden

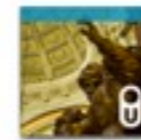

Cultuur
Zuletzt geändert: 15. Apr 2010
Tracks insgesamt: 60



Financieel management en economie
Zuletzt geändert: 15. Apr 2010
Tracks insgesamt: 189



Milieu en duurzaamheid
Zuletzt geändert: 15. Apr 2010
Tracks insgesamt: 3



Onderwijswetenschappen
Zuletzt geändert: 15. Apr 2010
Tracks insgesamt: 42

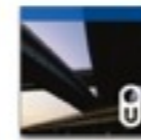

Organisatie, management en logistiek
Zuletzt geändert: 15. Apr 2010
Tracks insgesamt: 75



Overheidsmanagement
Zuletzt geändert: 15. Apr 2010
Tracks insgesamt: 18



Personeelsmanagement
Zuletzt geändert: 15. Apr 2010
Tracks insgesamt: 162



Psychologie
Zuletzt geändert: 15. Apr 2010
Tracks insgesamt: 384

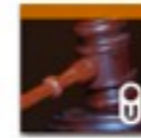

Rechten
Zuletzt geändert: 15. Apr 2010
Tracks insgesamt: 198

Centre for Learning Sciences and Technologies

Youtube Channel of the OU

Open Universiteit openuniversiteit's Channel [Subscribe](#) **Uploads** **Playlists** [Arrange Uploads](#)

Search Uploads [Date Added](#) | [Most Viewed](#) | [Top Rated](#)

2:56 Open Universiteit, de beste! 241 views 1 month ago	6:36 Thuis in de virtuele klas 741 views 5 months ago	6:28 Open Universiteit Lijsttrekkersdebat 156 views 5 months ago	4:56 Open Universiteit Lijsttrekkersdebat 73 views 5 months ago	2:06 Introductie Guido Thys 316 views 1 year ago	2:00 Ik heb geen zesjes mentaliteit en studeer 224 views 1 year ago
2:56 Open Universiteit, de beste! 241 views 1 month ago	6:36 Thuis in de virtuele klas 741 views 5 months ago	4:56 Open Universiteit Lijsttrekkersdebat 73 views 5 months ago	6:28 Open Universiteit Lijsttrekkersdebat 156 views 5 months ago	2:26 Partij voor de Dieren - Esther Ouwehand 314 views 5 months ago	1:50 Groen Links - David Rietveld 96 views 5 months ago
3:02 Piratenpartij - Samir Allioui 698 views 5 months ago	2:59 Evangelistische Partij Nederland - Yvette 223 views 5 months ago	2:07 Partij één - Yesim Candan 157 views 5 months ago	2:39 Heel Nederland - Daisha de Wijs 2,106 views 5 months ago	2:06 SGP - Marcel de Haas 110 views 5 months ago	1:33 Trots op Nederland - Arthur van der Putte 120 views 5 months ago

#2 eBooks, iPads, tablets



State of the art

- Woody et al, (2010): Study about preferences ebook/book
- No gender effects, no indication that previous ebook experiences influences choice, no diff. in learning outcomes



Table 2
Means, standard deviations, and univariate statistics for participants' self-reported use of special features and satisfaction with e-books and print books.

Measure	E-book	Print books	Tukey significance
How often they used the activities or online resources	4.76 (2.14)	4.44 (2.42)	$p > .05$
How often read section summaries	5.61 (2.33)	6.13 (2.07)	$p > .05$
How often answer study questions	4.76 (2.37)	5.26 (2.07)	$p > .05$
How often read captions and charts	4.93 (2.07)	5.94 (1.92)	$p < .05$
Satisfaction	5.33 (2.07)	6.83 (1.53)	$p < .01$

Note. Participants used a 9-point scale (1 = never, 9 = always) to respond to questions.

Two trends: PLE & ePub3

Area	EPUB 3 Specification	EPUB 2.0.1 Specification
Overview	EPUB 3 Overview	(throughout)
Publication-level Specification & Package Docs	EPUB Publications 3.0	Open Packaging Format 2.0.1
Content-level Specification	EPUB Content Documents 3.0	Open Publication Structure 2.0.1
EPUB Navigation Documents	EPUB Content Documents 3.0	N/A (NCX referenced as DAISY specification)
Media Overlays	EPUB Media Overlays 3.0	N/A
Container packaging	EPUB Open Container Format 3.0	Open Container Format 2.0.1
Changes from previous version	EPUB 3 Changes from EPUB 2.0.1	(throughout)



Two trends: PLE & ePub3

ePub3

- HTML5
- Media Overlays
- Scripting
- MathML
- Accessibility

EPUB3: Rich Media Enhancements

- Video & audio support
 - Declarative event triggers (custom controls w/out JavaScript)
- Audio can be synchronized with text
 - SMIL & CSS Speech subsets
- Embedded font support a conformance requirement
 - OpenType / WOFF
- Improved SVG integration

© 2010 Bill McCoy



Content Bundles via iBooks

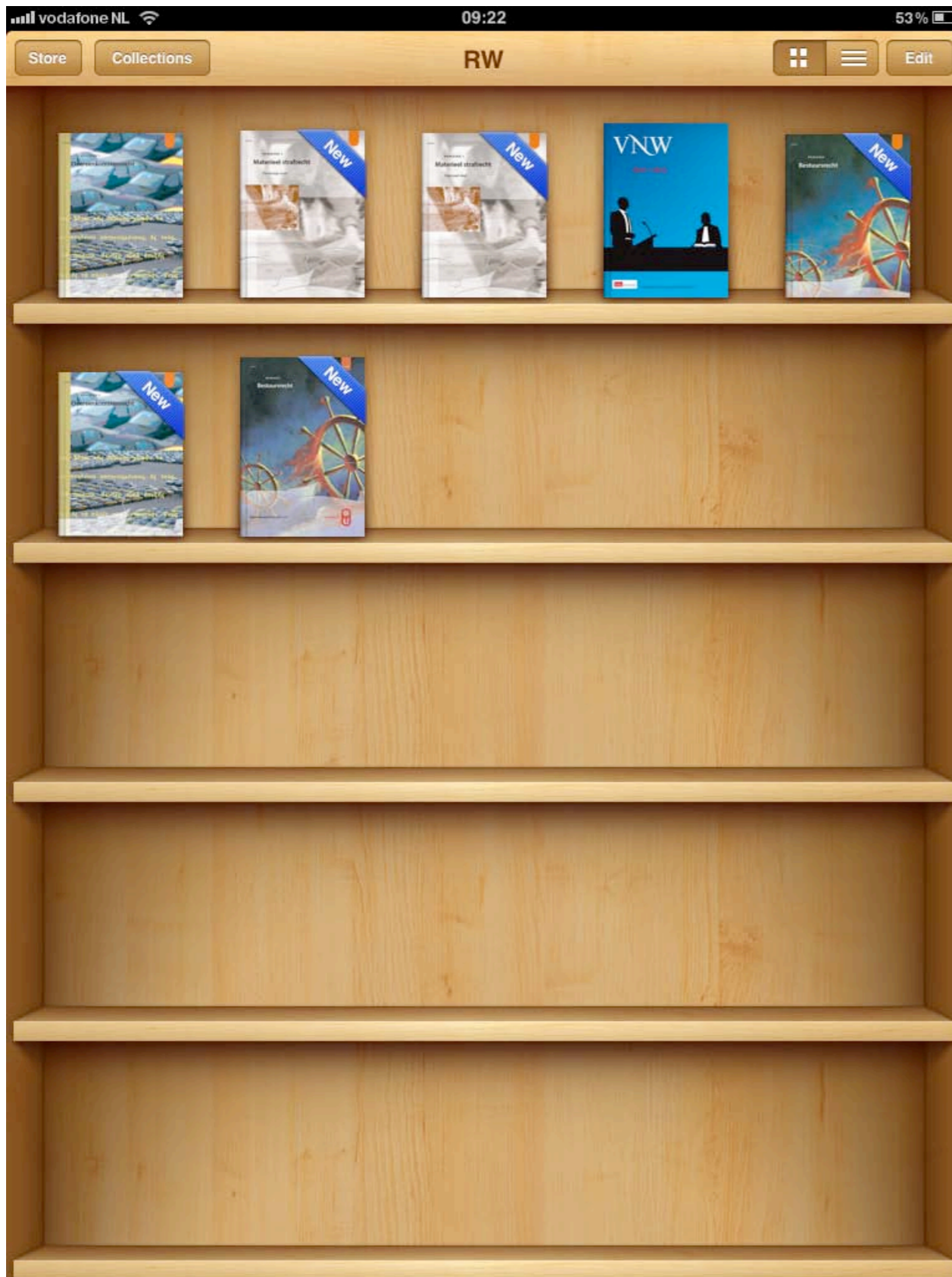

Content > Reflective eBooks > advanced eBook functionalities for personalised learning

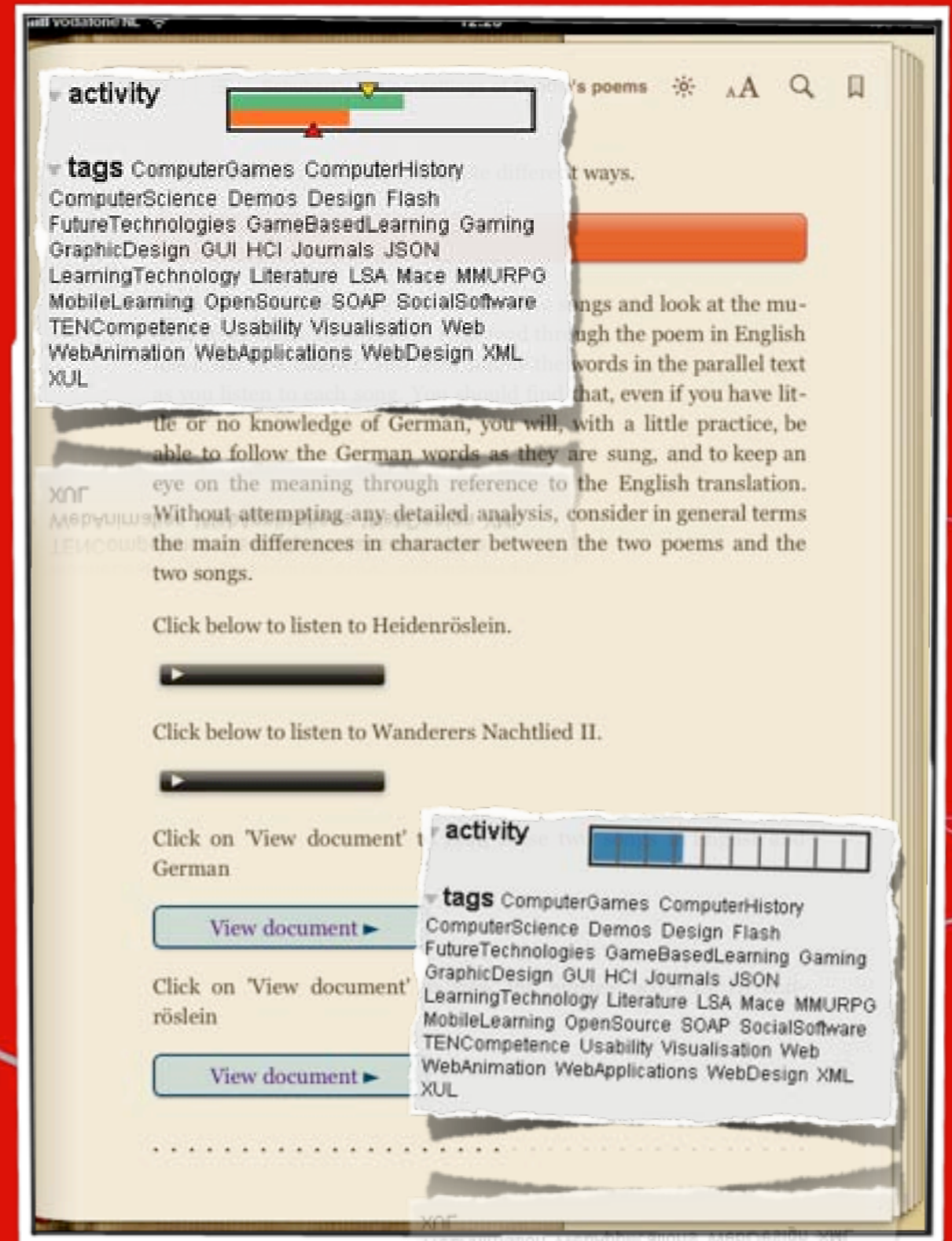
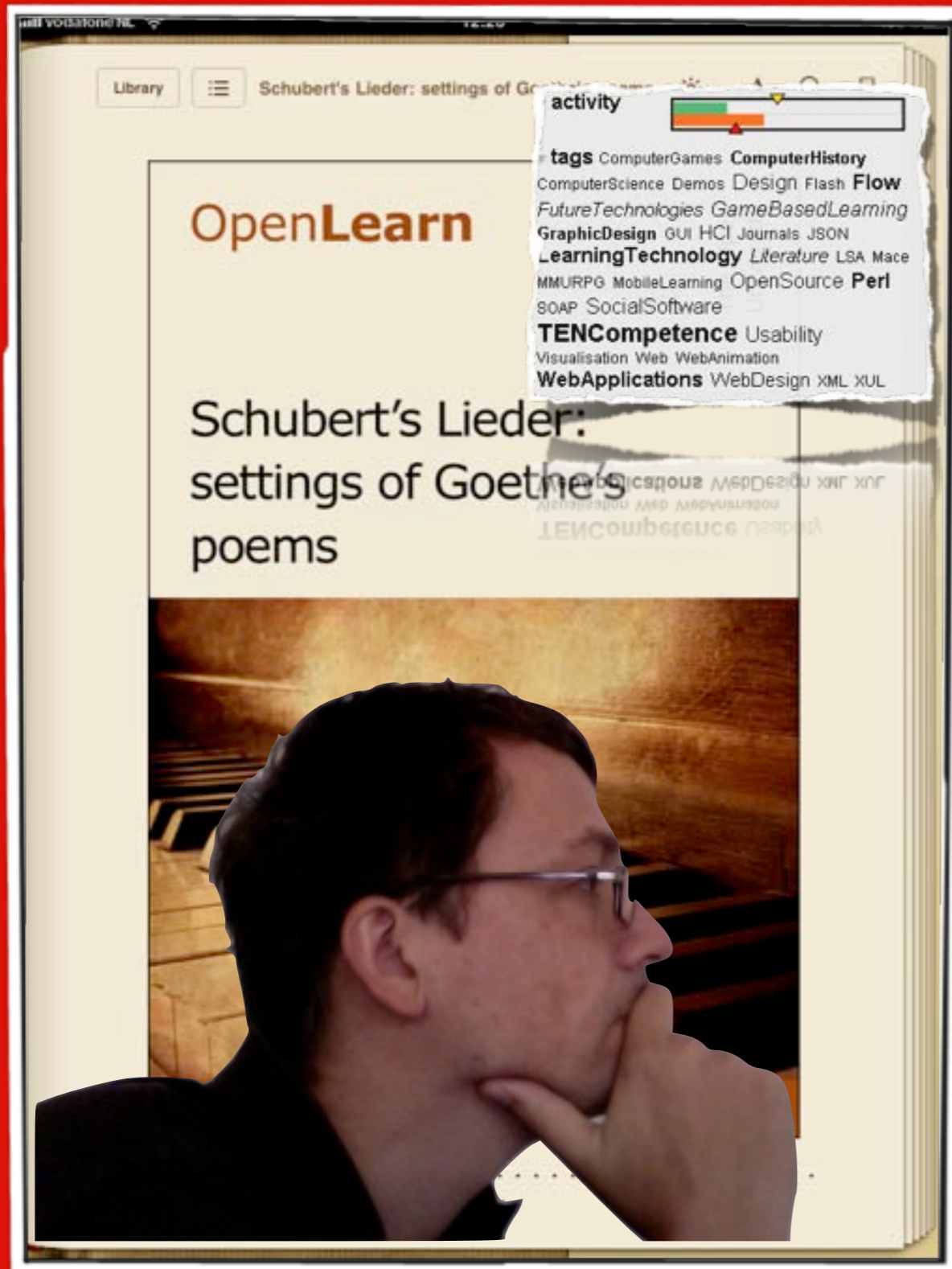

#3 Mobile and Ubiquitous LMS



Mooble LMS

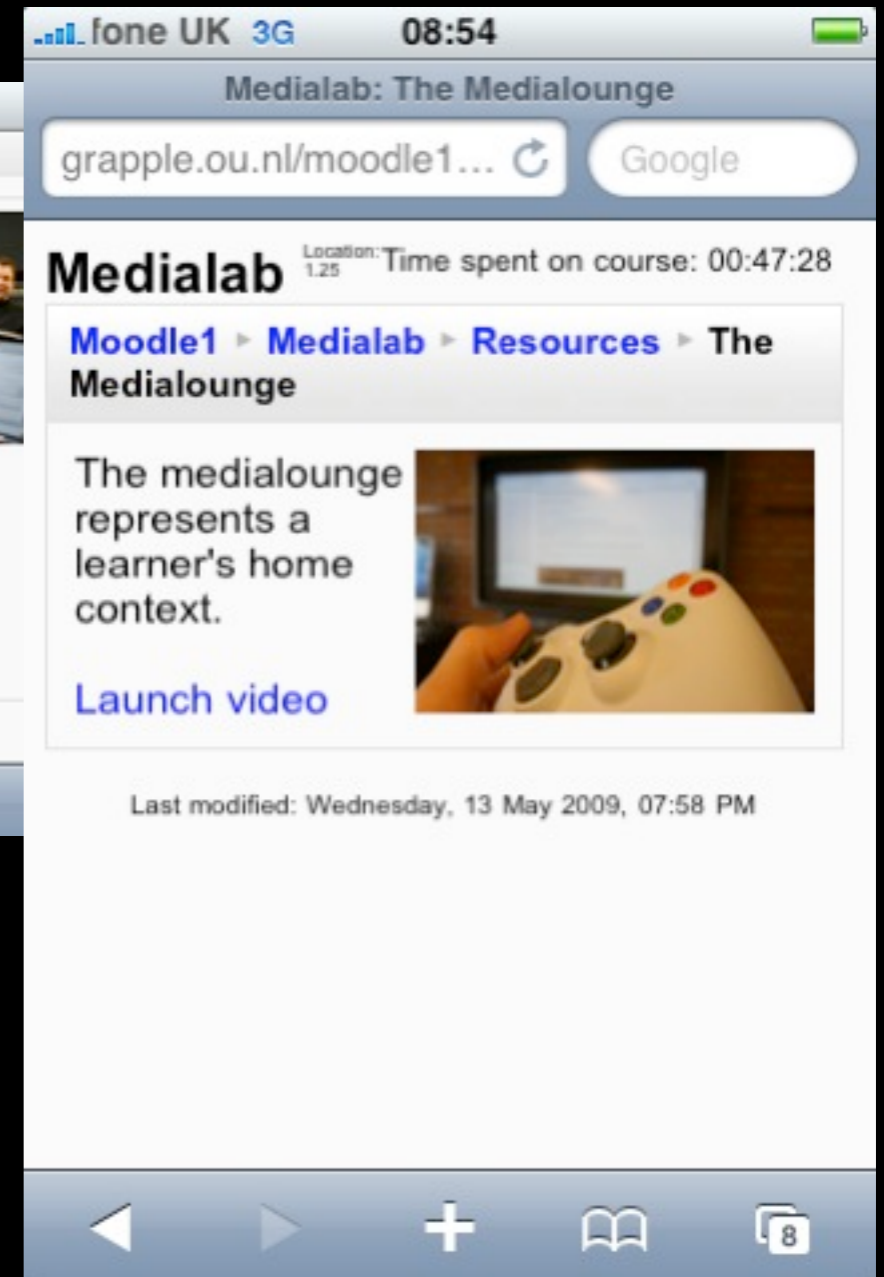

Glahn, C., & Specht, M. (2010). Embedding Moodle into Ubiquitous Computing Environments. In M. Montebello, et al. (Eds.), 9th World Conference on Mobile and Contextual Learning. October, 19-22, 2010, Valletta, Malta.
<http://hdl.handle.net/1820/2729>



Blackboard Mobile Learn

#4 cloud-based University, augmented Campus

Centre for Learning Sciences and Technologies

Open Universiteit
celstec.org



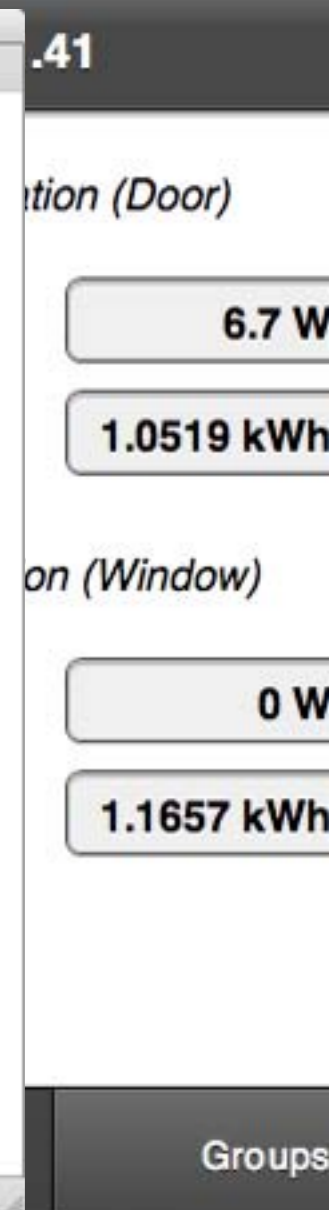
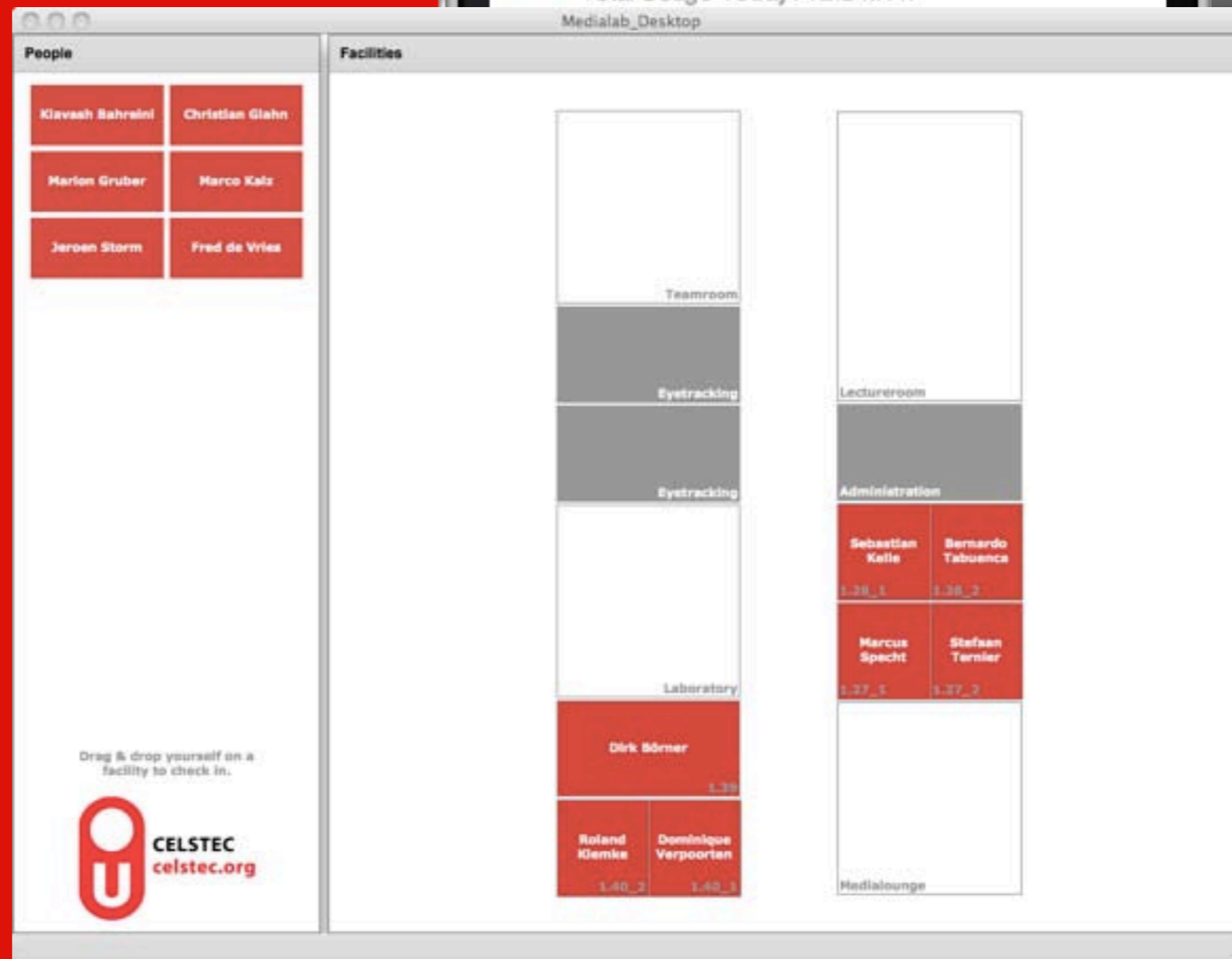
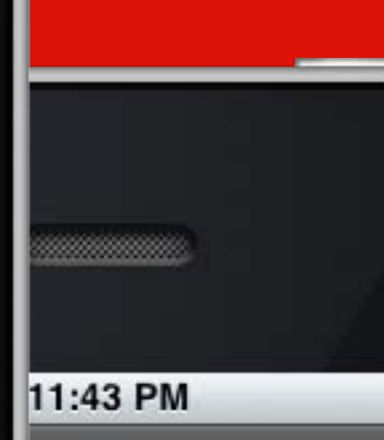

g Sciences and Technologies

STYLE

all

filter

lock

BUILDINGTYPE

all

filter

lock

ARCHITECT

all

filter

lock

MAP

mæeve

MACE | EVERYVILLE

interactive installation at the Venice Biennale '08

and different forms of exploration:
The MACE experience

MACE ContextBlogger



Username

Password

Login



Objects + Add object

- Universiteits bibliotheek... 3 1
- Aatrial House 4 5
- Empire Island Tower 3 4
- Penang Global City Center 1 7
- Light*house in Aarhus 3 4
- Suntro House 7 1
- BMW Headquarters 3 8
- Apeiron 3 6
- Beijing Grand Theatre 9 9

Exit Menu



Back Photos + Add Photo

Universiteits bibliotheek Utrecht
click on image to enlarge

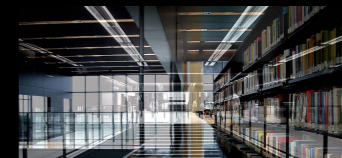

Exit Menu



Back Add object

Title

+ Add Photo Photo 1.jpg, Photo2.jpg,...

GPS coordinates

Description

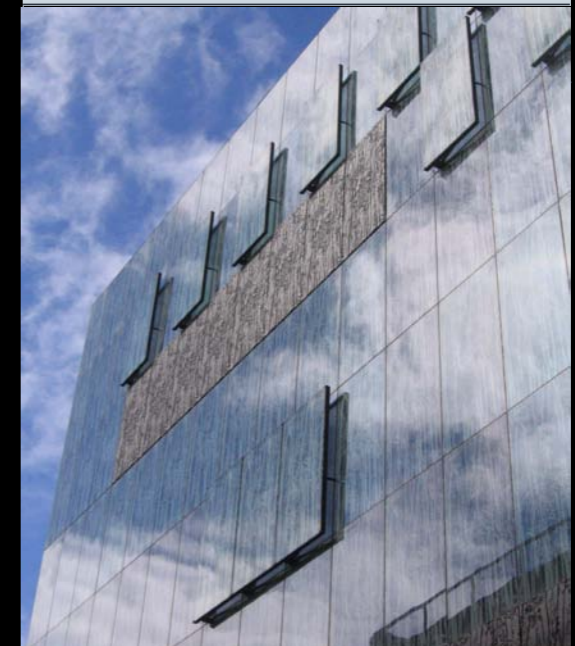

Object Tagging/Augmentation to link to content and channels to real world objects

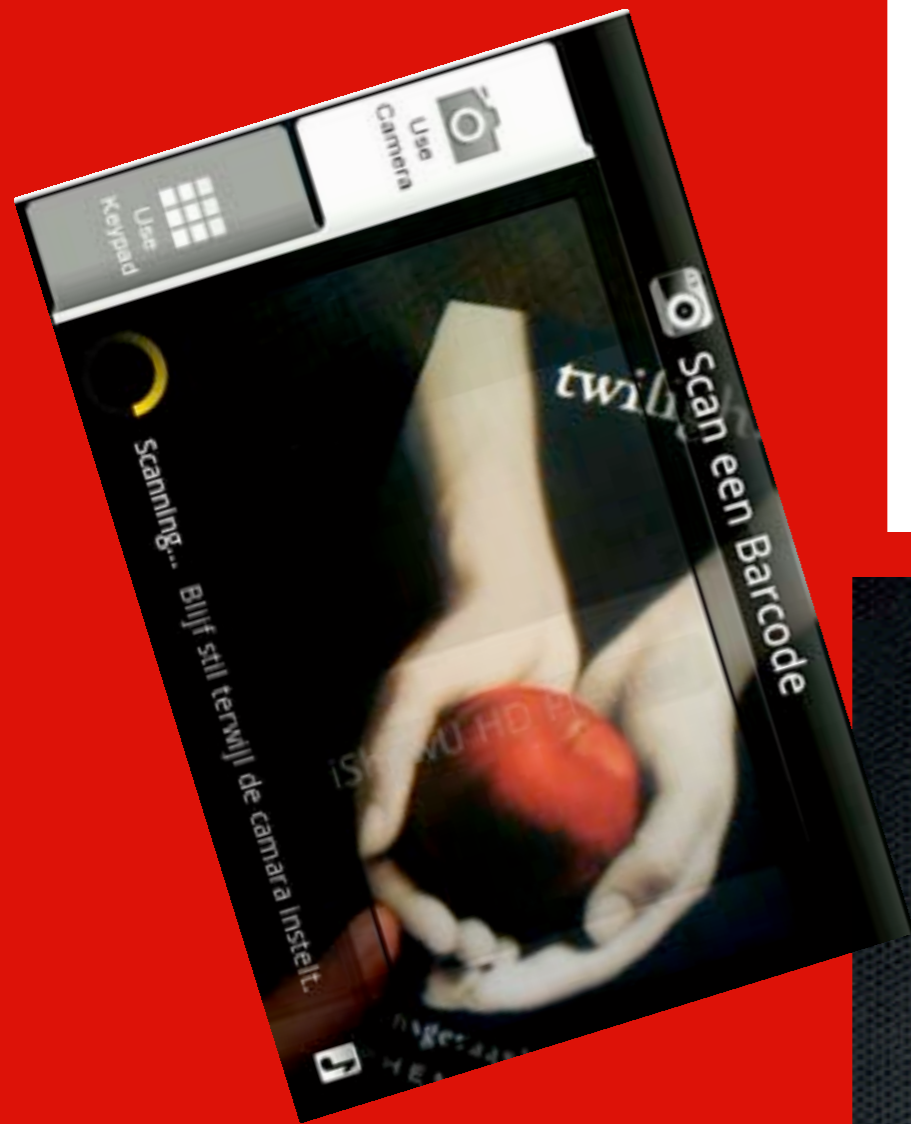

Centre for Learning Sciences and

augmented reality content ...



Cultuurwetenschappen

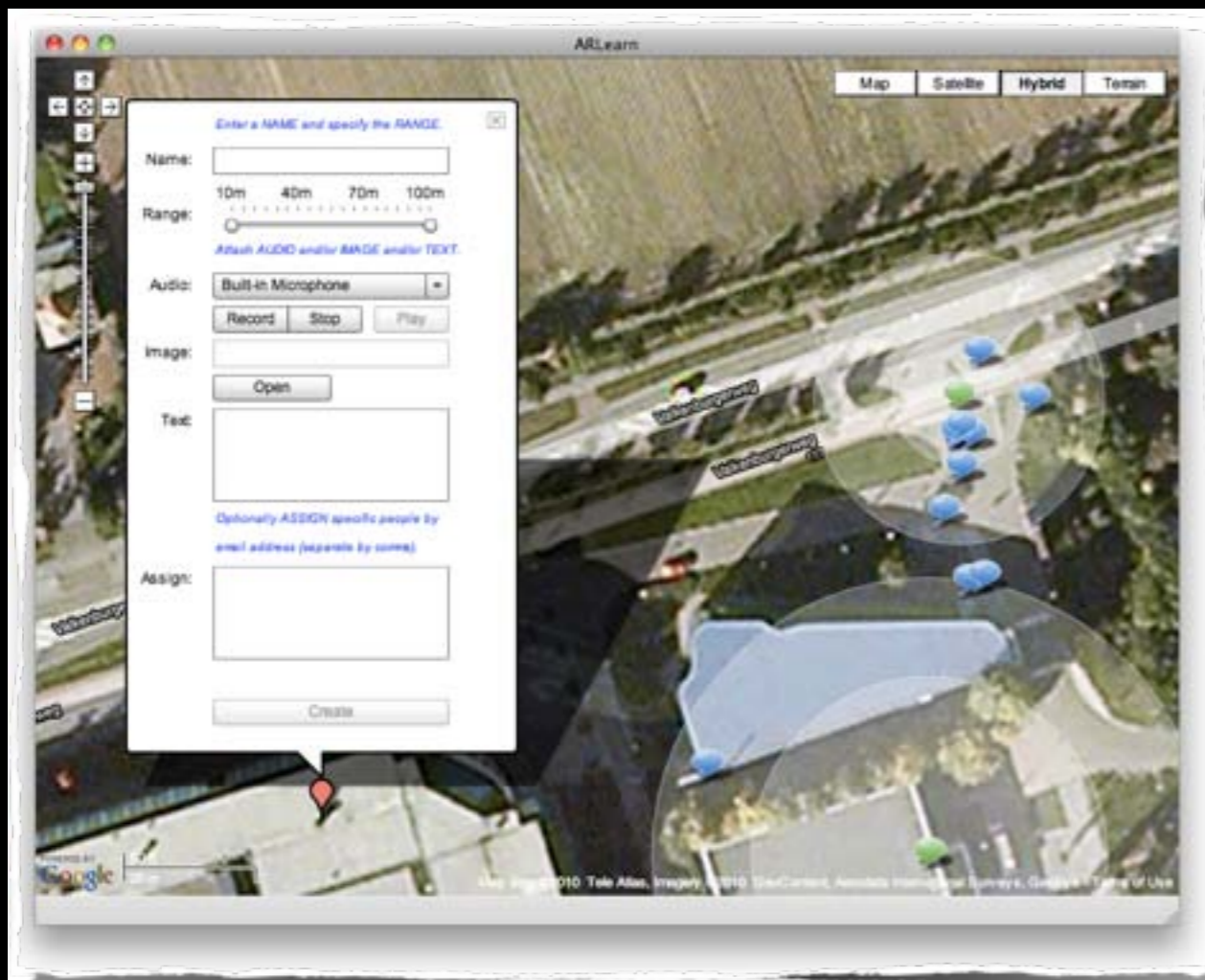

**#5 are you ready for
a change to the better ?**



#1 are your contents and legacy information systems accessible by mobiles and ubiquitous technology?

wap, mobile browser, app, embedded displays, service APIs

#2 what functionality do your
users want mobile?

grades, content, ...

#4 what activities in the real world actually trigger the learning experience or the reflection?

integration in the workflow?



www.openU.nl,
teleurope.eu,
celstec.org,
marcuspecht.de